

Quick Card

OneAdvisor ONA-800

Measuring Light Levels with the MP-60 and MP-80 Optical Power Meters

The following procedure outlines how to use the VIAVI ONA-800 equipped with an MP-60 or MP-80 external USB Optical Power Meter.

Equipment Requirements:

- ONA-800 with Firmware version 1.1.0 or greater
- MP-60 or MP-80 USB Optical Power Meter
- Fiber optic cleaning and inspection tools
- Patch Cable with connectors matching the Power Meter and Fiber Under Test
- Optical Coupler to connect Patch Cable to the Fiber Under Test



Figure 1: Equipment Requirements

The following information is required to complete the test:

- Type of Fiber (Multimode or Single Mode)
- Type of Connectors (SC UPC, SC APC, LC UPC, etc.)
- Wavelength of signal(s) to measure

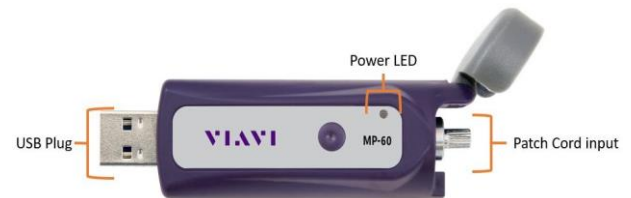

Figure 2: MP-60 Optical Power Meter

Fiber Inspection Guidelines:

- All fiber end-faces must be clean and pass an inspection test prior to connection.
- Use the VIAVI P5000i or FiberChek Probe Microscope to inspect both sides of every connection being used (SFP/QSFP Port, bulkhead connectors, patch cables, etc.)

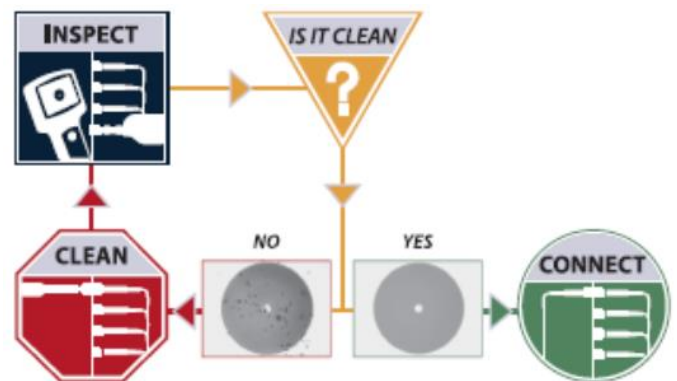

Figure 3: Inspect Before You Connect

Connect to the Fiber Under Test:

1. Insert the MP-60 or MP-80 into a USB port on the top of the ONA-800.
2. Open the flap to expose the Patch Cable Input. The Standard Patch Cable Input is 2.5mm and supports SC, FC, and ST patch cables. A 1.25mm adapter is available as an option. To swap, unscrew the existing adapter and carefully screw the desired adapter in its place.

3. Connect to the Fiber or Light Source under test:

- If the device under test is a patch cable with a ferrule size that matches the Patch Cable Input on the Power Meter, it can be inserted directly into the Patch Cable Input.
- If the device under test is an Optical Patch Panel, SFP or other optical transceiver, use a patch cable with connectors matching the Power Meter's Patch Cable Input and the SFP or transceiver under test.

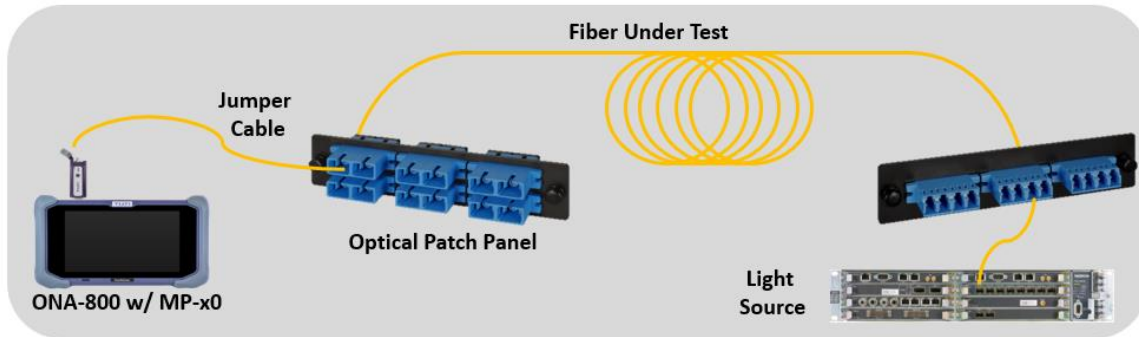

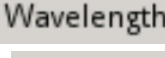
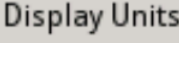

Figure 4: Connecting the Power Meter to an OPP

Measure Absolute Power:

1. Press the Power button  to turn on the ONA-800.
2. Tap the **PowerMeter** icon  in the Status Bar at the top of the ONA-800.
3. Tap the **Wavelength** drop-down menu  or scroll wheel to select the wavelength.
4. Tap the **Display Units** drop-down menu  and set units to **dBm**.
5. View the power level in the **USB Power Meter Summary** Results display at the top of screen.

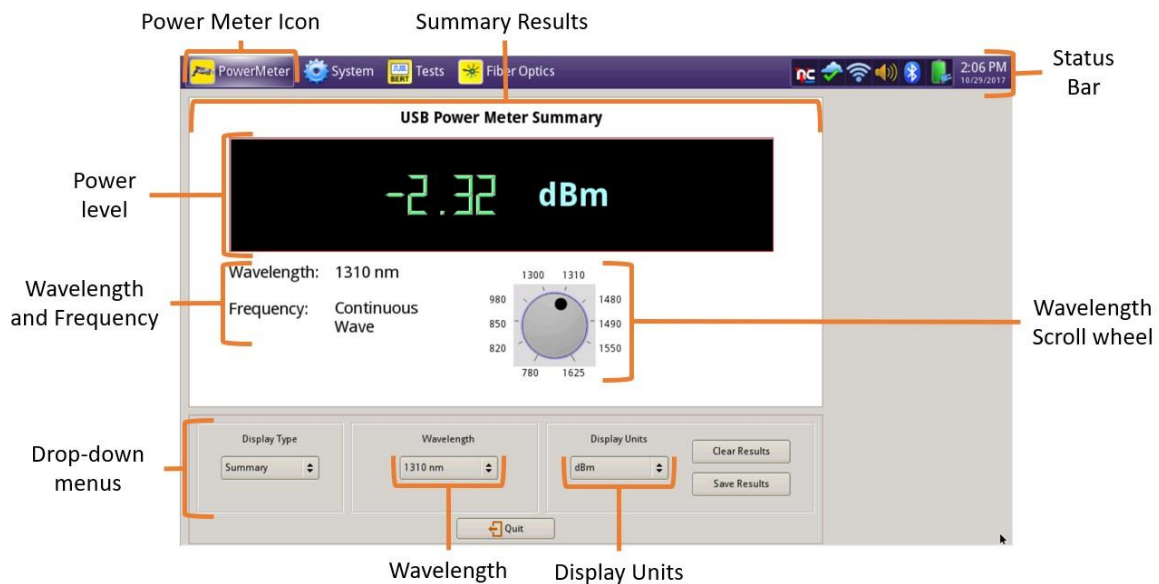

Figure 5: Summary View