

Measuring the 1x32 Splitter Using Easy OCETS

Introduction

VIAMI Optical Components Environmental Testing System (OCETS) has enjoyed a great success since its first release over 10 years ago. Recently, driven by the fiber to the home initiative, there is a growing demand in the market for the system that's capable of qualifying not only the jumpers but the splitters and couplers beyond the return loss of 65dB. The splitting ration can be anywhere from 1 by 2 to 1 by 32.

This application note demonstrates the details of measurement for 1x32 splitter by Easy OCETS software. It also provides information on how to setup the system.

Description

Optical Component Environmental Test SystemPlus (OCETSPlus) is an automated test facility for longterm reliability testing of passive optical components under environmental stress condition such as temperature and humidity. The new version of OCETSPlus keeps all the key features of legacy OCETS, but extending the following measurement abilities.

First, it extends the ultra-high return loss measurement beyond 65dB. The certain IL limitation of DUT for high return loss measurement with the legacy OCETS is removed for the OCETSPlus.

Second, it not only allows the bidirectional measurement in ultra high return loss, the type of DUT is also extent from 1x1 in OCETS to 1xN (N =2 to 32) in the OCETSPlus. All the key parameters permitted to monitor with Easy OCETS software are:

- Insertion Loss (IL)
- Polarization dependent loss (PDL)
- Ultra-high return loss (RL) beyond of 65dB are permitted to monitor with Easy OCETS software.

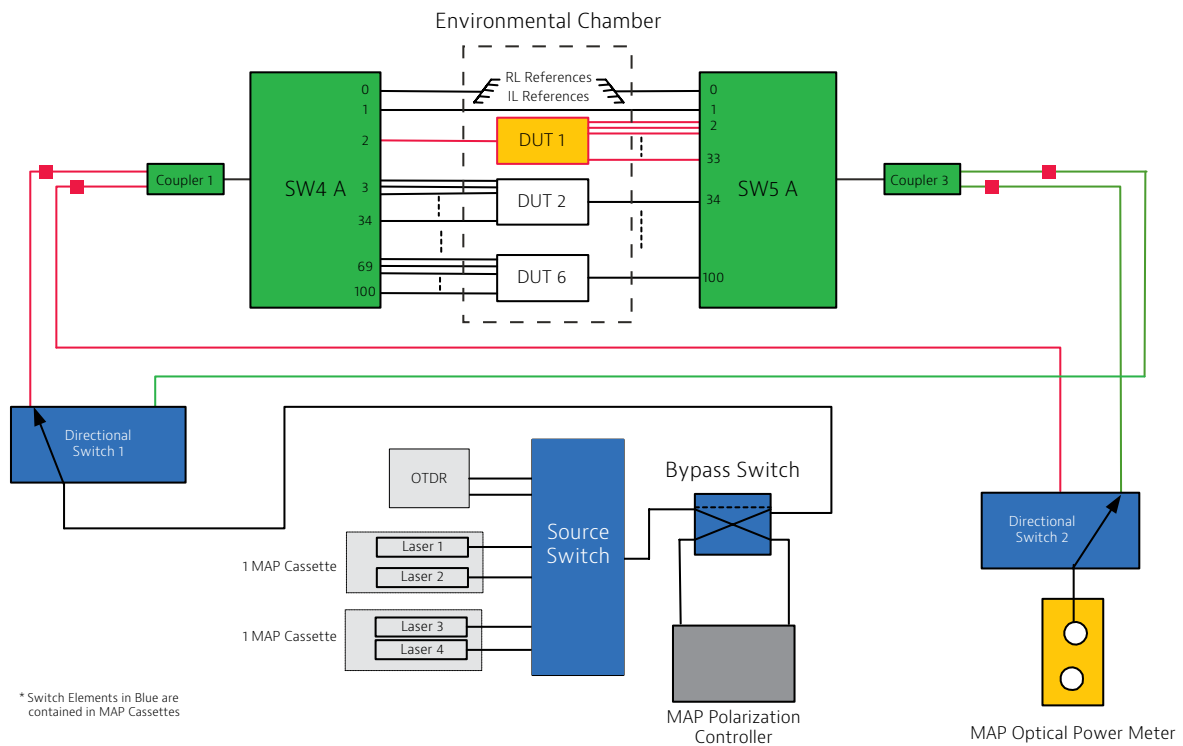

Figure 1: Typical OCETSPlus Bidirectional Test Configuration for 1x32 splitter

In a generic layout (Figure 1), the main routing elements are a pair of high quality VIAVI programmable switches (1 x N configuration; SW4 & SW5). The devices under testing (DUTs) are inserted into the fiber lines joining the N channels of the switches. By operating these two switches, each DUT channel can be monitored sequentially from a light source to the power meter. The other VIAVI MAP switches (SW1, SW2 and SW3) serve to couple the different sources into the channels; optionally go through the polarization controller; and permit the measurements of all key parameters in bidirectional configuration. The two high directivity wide band couplers are installed for ultra-high RL measurement. These switches and couplers, combined with the appropriate internal or external sources, a VIAVI polarization controller (PCS), a VIAVI optical power meter (OPM) plus Easy OCETS software, create a fully automated turnkey measurement facility. Compared with the legacy OCETS, the OCETSPlus is more compact. All VIAVI MAP laser sources, switches (SW1, SW2 and SW3), a polarization controller (PCS) and an optical power meters (OPM) are mounted in the VIAVI Multiple Application Platform (MAP) chassis.

Ultra-high RL measurement

In the OCETSPlus, we have two options for RL measurement. The first is suitable for the relatively low RL up to 55dB. The advantage is the measurement time is relatively fast. The algorithm is the same as the legacy OCETS. The second is designed for ultra-high RL up to 70dB. This option requires the system be calibrated ahead of time.

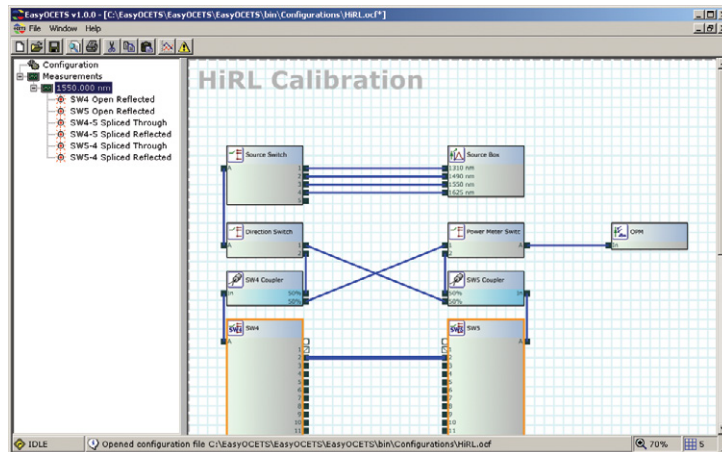

Figure 2: New "HiRL Calibration" configuration with Easy OCETS

The ultra-high RL calibration is processed by a HiRL analysis plug-in to Easy OCETS software as shown in figure 2. The procedures are designed for calibration with all specific source wavelengths and six predefined steps. The purpose of calibration is served to correct any internal systematic back reflection originated from SW4 and SW5 switch pair in bidirectional way. A HiRL calibration table will be created to contain all the internal reflected power level versus each channel and each specific wavelength.

When the ultra-high RL is measured with the OCETSPlus, two additional factors are considered. First, if the DUT has a relatively large IL, as it is connected between SW4 and SW5, the internal reflected power from SW4 and SW5 to the power monitor will be changed from the calibrated values. In this case, the OCETSPlus will measure the corresponding IL of DUT in each channel. The measured IL values are used to compensate the internal back reflection from SW4 and SW5. Second, as the ultrahigh RL measurement is claimed, the Rayleigh back scattering from fiber has to be considered. In the HiRL calibration, one more step is necessary to fill the fiber lengths for each channel. The fiber length changes before and after the DUT connected to SW4 and SW5 will be required during the ultra high RL measurement.

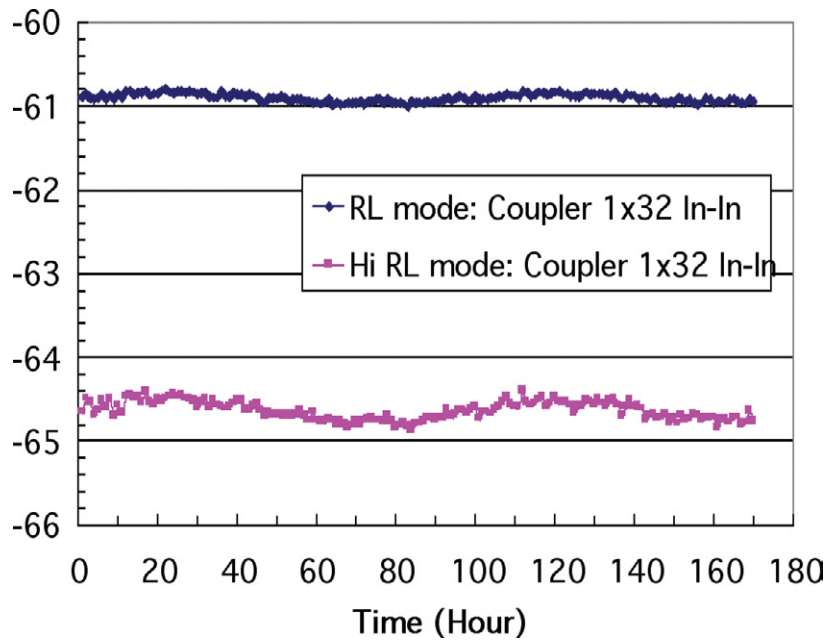

Figure 3: Comparison of regular RL and high RL mode of a 1x32 splitter with the OCETSPlus of a 1310nm laser over 170 hours

Figure 3 presents an example of regular RL and ultra-high RL measurement in the OCETSPlus with a 1310nm laser over 170 hours in the room temperature. The DUT is a 1x32 splitter and the measured RL corresponds to the input port. As shown, the ultra-high RL option increases the RL measurement capability with slightly sacrificing the noise level. Table 1 shows the specification of RL repeatability for single mode application.

In the in-band operation, certain resource blocks are allowed for NB-IoT They are restricted to the following values:

Parameter	RL Range	Repeatability	Unit
RL repeatability over 100 hours	Up to 55dB	± 0.5	dB
	Up to 65dB	± 1	
	Up to 70dB	± 3	

Table 1

Multi-port device

In the OCETSPlus, a multi-port DUT can be measured in the bidirectional configuration with the Easy OCETS software as shown in figure 4. The multi-port is extended up to 1x32 and the bidirectional testing is designed for all the key parameters IL, PDL, RL and ultra-high RL. Table 2 shows the specification of IL and PDL repeatability for single mode application.

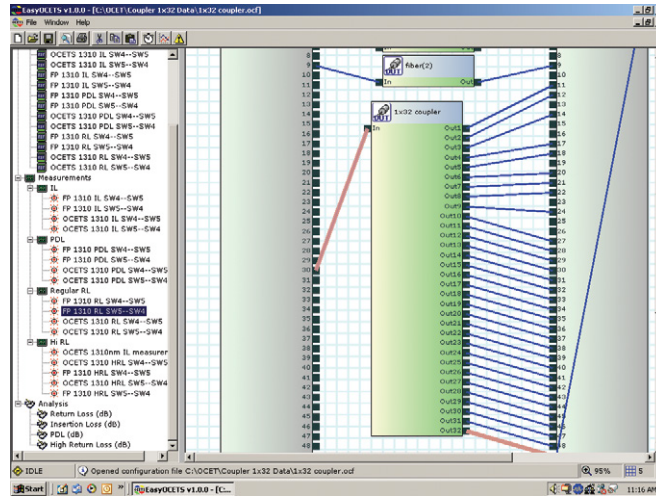

Figure 4: 1x32 splitter configuration with Easy OCETS

In the in-band operation, certain resource blocks are allowed for NB-IoT They are restricted to the following values:

Parameter	IL Range	Repeatability	Unit
IL/PDL repeatability over 100 hours	0 to 50dB	± 0.04	dB
	0dB	± 0.08	

Table 2

Although the OCETSPlus is usually used for a relative measurement such as long term IL, PDL and RL repeatability and stability testing, some of the absolute measurement results are also reliable. Figure 5 shows the averaged IL of a 1x32 splitter in bidirectional configuration with the OCETSPlus of a 1310nm laser over 170 hours. The ILs measured from "In to Output CH" and "Output CH to In" corresponding to each channel are very close.

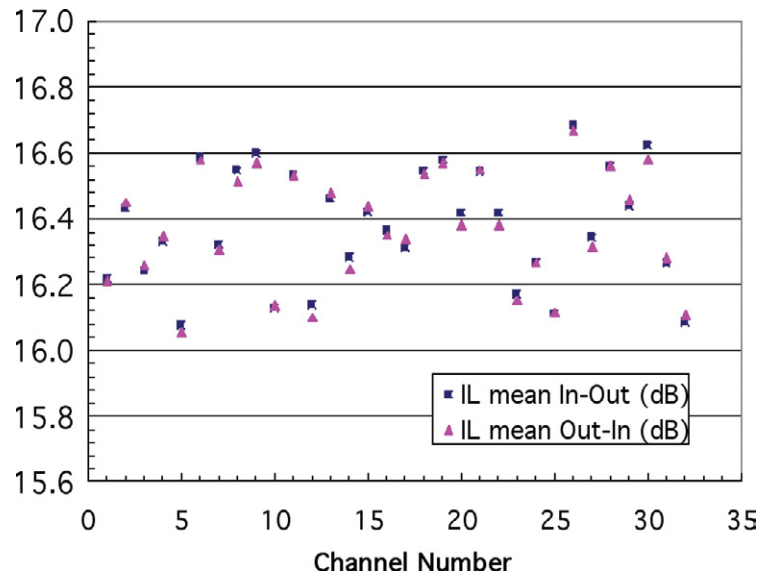

Figure 5: The averaged IL of a 1x32 splitter in bidirectional configuration with the OCETSPlus of a 1310nm laser over 170 hours

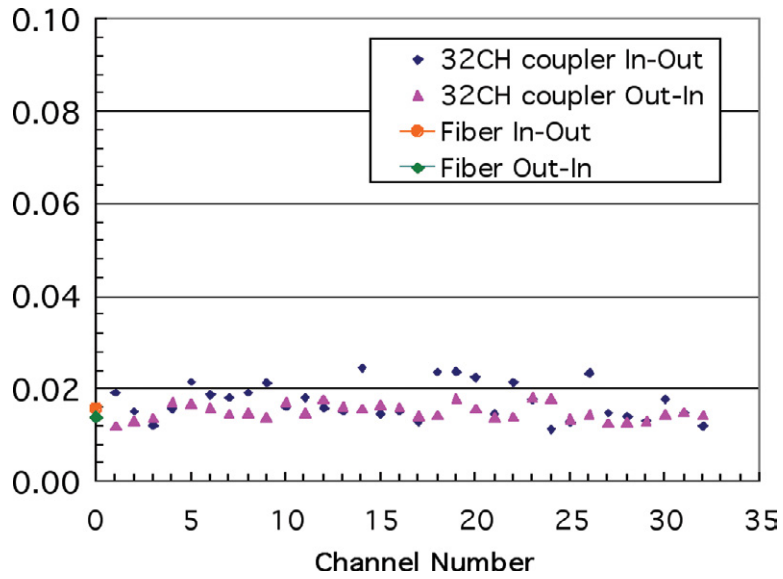

Figure 6: The IL repeatability of a 1x32 splitter in bidirectional configuration with the OCETSPlus of a 1310nm laser over 170 hours

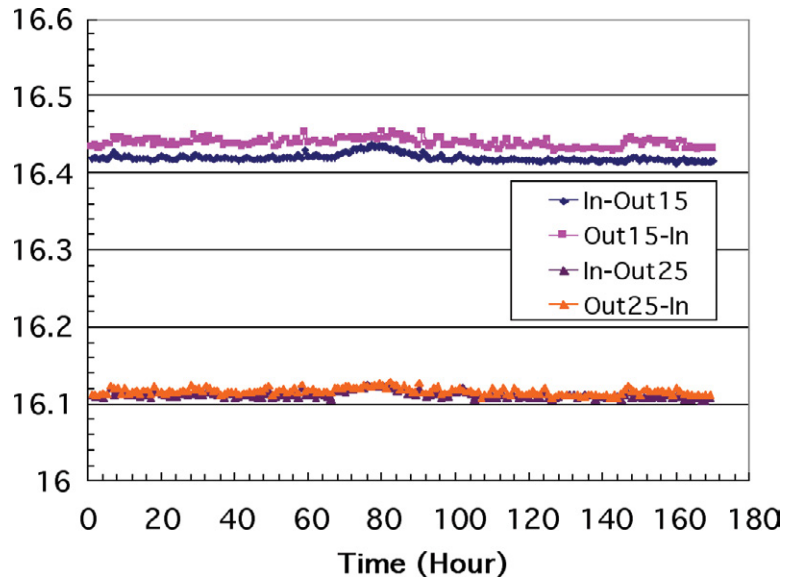

Figure 7: The PDL repeatability of a 1x32 splitter in bidirectional configuration with the OCETSPlus of a 1310nm laser over 170 hours

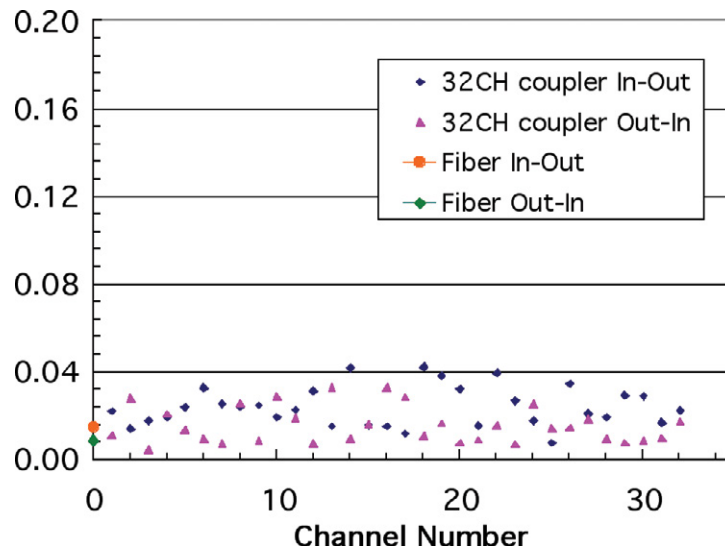

Figure 8: The IL of CH15 and CH25 of a 1x32 splitter in bidirectional configuration with the OCETSPlus of a 1310nm laser over 170 hours

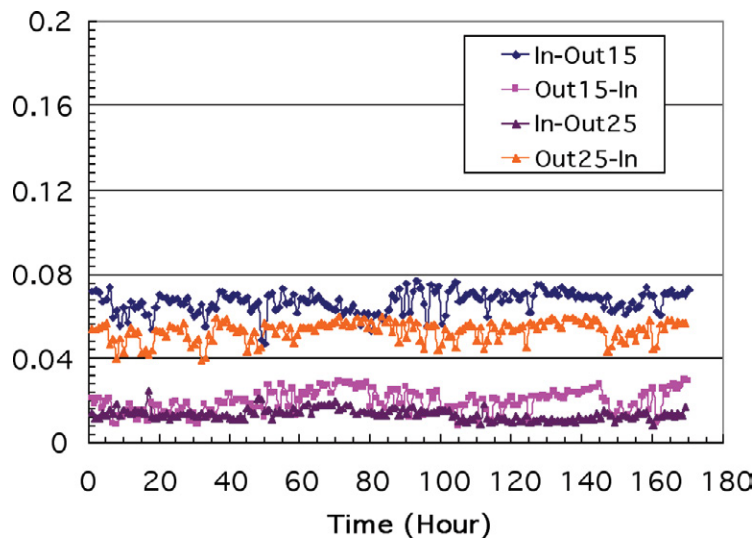

Figure 9: The PDL of CH15 and CH25 of a 1x32 splitter in bidirectional configuration with the OCETSPlus of a 1310nm laser over 170 hours

The IL repeatability for each channel over 170 hours is shown in figure 6, which includes both the OCETSPlus and DUT IL repeatability at room temperature. As a comparison, the IL repeatability of a fiber jumper connected as a DUT is also presented in figure 6. In figure 7, the IL evolution over 170 hours for certain channels in bidirectional configuration is plotted.

The measurement of PDL with a 1x32 splitter in bidirectional configuration at room temperature over 170 hours is presented in figure 8 and 9. Similar to the IL measurement, the PDL repeatability in figure 8 represents the both the OCETSPlus and DUT PDL repeatability. A fiber jumper is used as a reference in the PDL repeatability. The PDL evolution over 170 hours for certain channels in bidirectional configuration is plotted in figure 9.

The Easy OCETS application software

The Easy OCETS design addresses many of the limitations of the legacy OCETS software, and introduces great new features. The application is built using the Microsoft .NET framework, and thus will operate optimally on Windows XP and Windows 7. Easy OCETS is a totally configurable system, and is not tied to a specific hardware configuration. As a matter of fact, it is able to control any standard optical instrument, by using "plug-in" instrument drivers. Data analysis was designed to be configurable by way of the same plug-in technology. The user is able to visually set up the system configuration by dragging instrument drawings on a canvas, and optically connecting the ports.

Another enhancement is a multi-threaded test scheduler that can make simultaneous calls to different instrument drivers, thus speeding up the entire testing process.

The OCETS Software has the following software parts:

- System Configuration: provides the interface to let user setup the system device configuration, devices under test (DUTs) configuration, instrument driver and test configuration.
- Scheduler: Control of the whole test sequence based on frequency or time.
- Log mechanism.
- Measurements.
- Analysis plug-in: User will be able to use existing analysis and create his own using Visual Studio.
- Instrument drivers plug-in: a list of drivers for all instruments that connect with the OCETS system.
- Database: Save the test records and results.
- Data viewer: With user define filters for graphical data display and export.

Conclusion

This Application Note has illustrated the details of performing 1x32 measurement using newly developed OCETSPlus. It offers a distinct advantage over legacy OCETS with respect to ultra-high RL measurement, bidirectional configuration for all key parameters, and multi-port device functionality.

The inclusion of EasyOCETS application software now enables creation of an automatic measurement facility for long-term reliability and environmental testing.



Contact Us **+1 844 GO VIAVI**
(+1 844 468 4284)

To reach the VIAVI office nearest you,
visit viasolutions.com/contact

© 2020 VIAVI Solutions Inc.
Product specifications and descriptions in this
document are subject to change without notice.
1x32coupler.an.fop.tm.ae
30149077 001 0710